

NOTICE
All information contained within this document is the sole property of Bossen Architectural Millwork Inc. Any reproduction, misrepresentation, or alteration of this document without written permission is strictly prohibited.

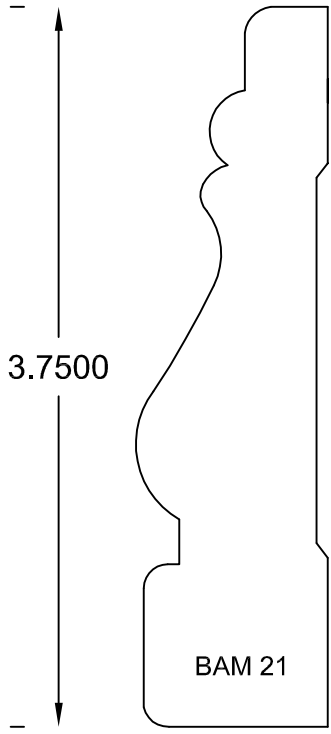

BAM 21

0.9576

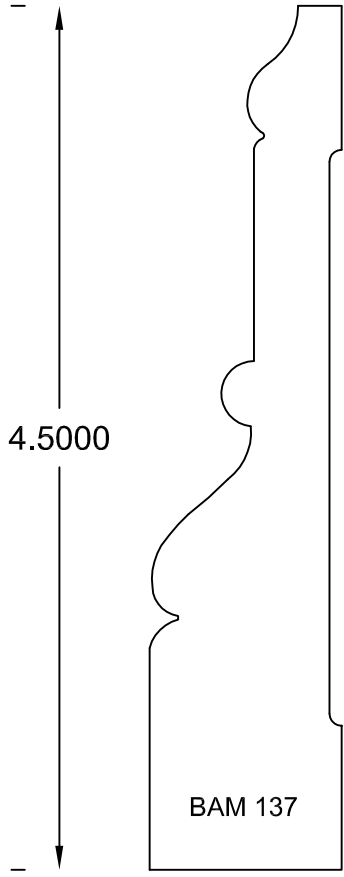

BAM 137

1.0000

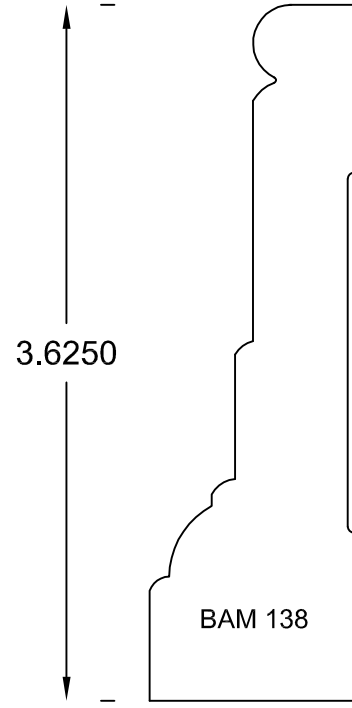

BAM 138

1.0625

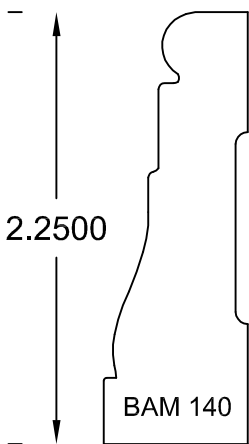

BAM 140

0.7500

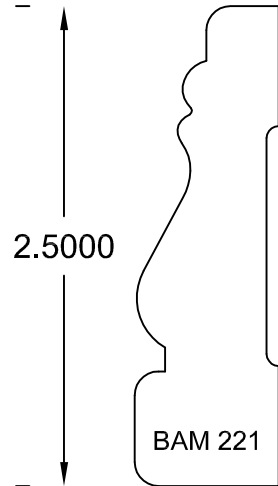

BAM 221

0.7500

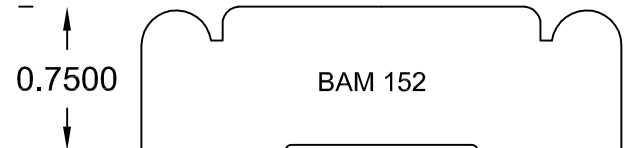

BAM 152

2.5000



BAM 449

2.7500

Traditional Collection Specification Sheet
These are STOCK items.

SCALE ~ 1:1
Date: 3/8/10 by:AEB
Spec Pg: 1

Bossen Architectural Millwork Inc.
© 2010
1818 Bannard Street
Cinnaminson, New Jersey 08077
PH 856-786-1100
FAX 856-786-3994
www.Mouldings-Etc.com

NOTICE
All information contained within this document is the sole property of Bossen Architectural Millwork Inc. Any reproduction, misrepresentation, or alteration of this document without written permission is strictly prohibited.

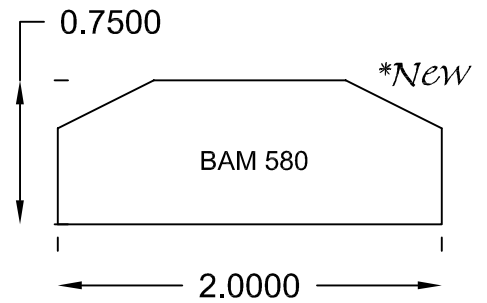
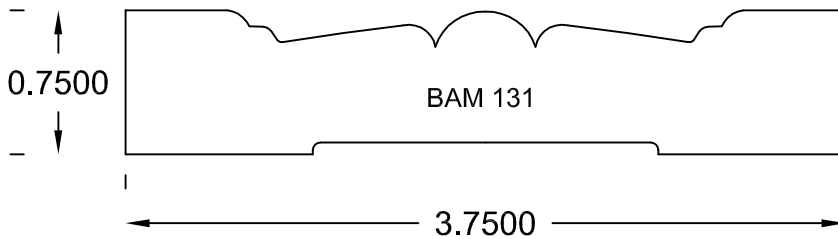
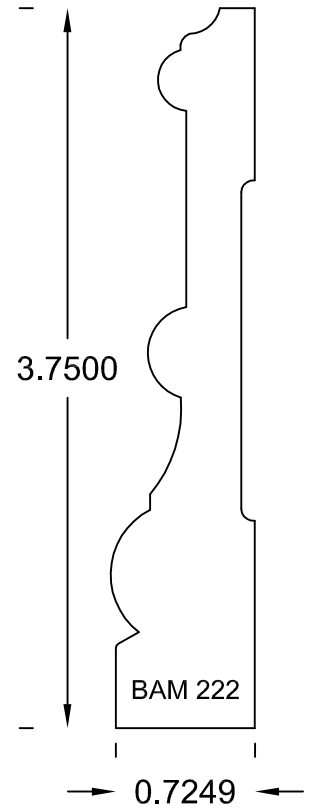
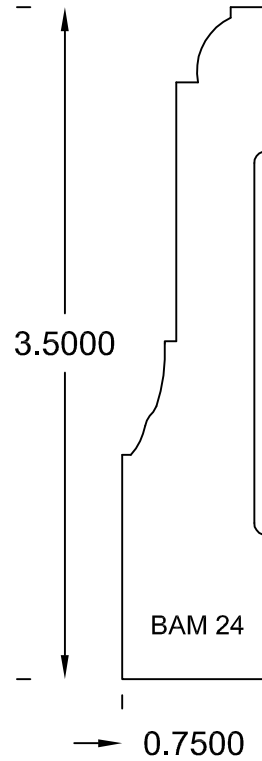
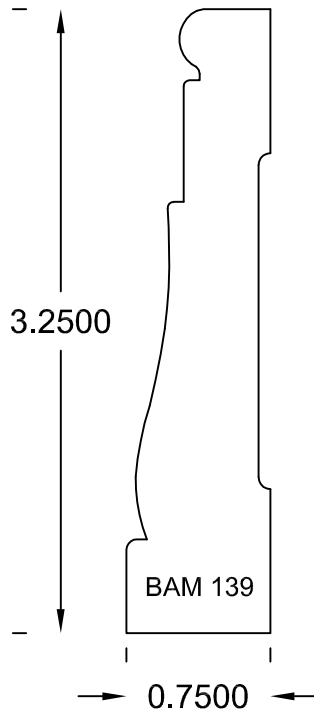
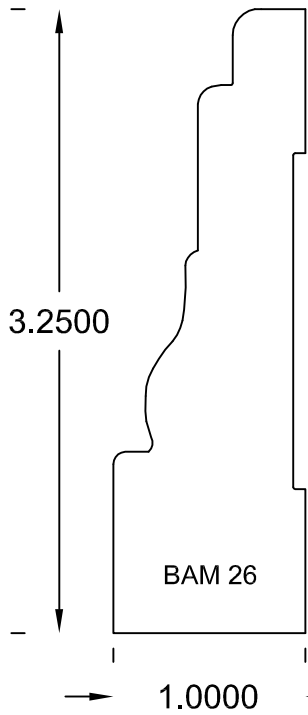

Traditional Collection Specification Sheet
These are STOCK items.

SCALE ~ 1:1
Date: 3/8/10 by:AEB
Spec Pg: 2

Bossen Architectural Millwork Inc.
© 2010
1818 Bannard Street
Cinnaminson, New Jersey 08077
PH 856-786-1100
FAX 856-786-3994
www.Mouldings-Etc.com

NOTICE

All information contained within this document is the sole property of Bossen Architectural Millwork Inc. Any reproduction, misrepresentation, or alteration of this document without written permission is strictly prohibited.

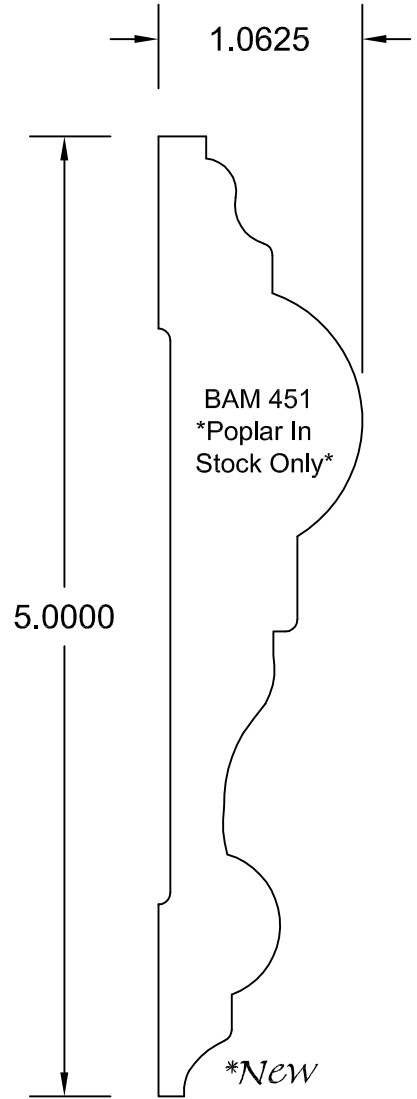
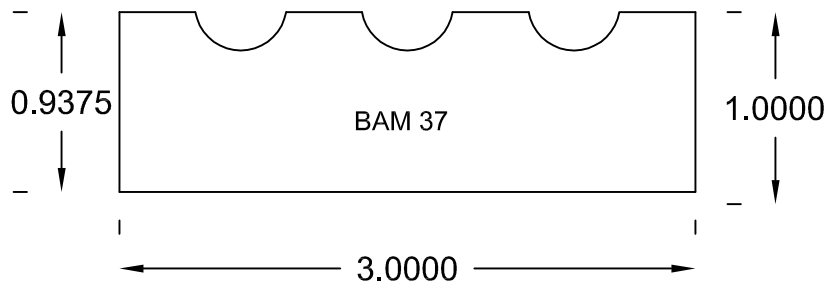
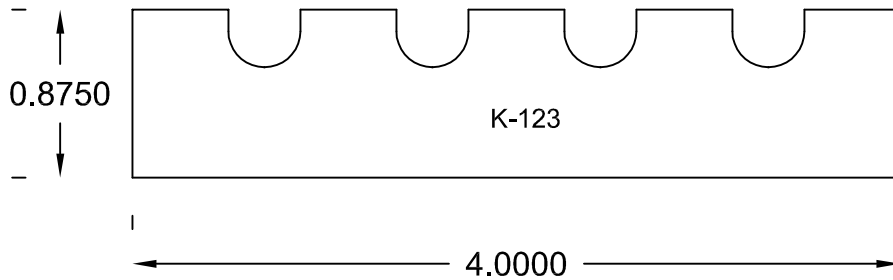
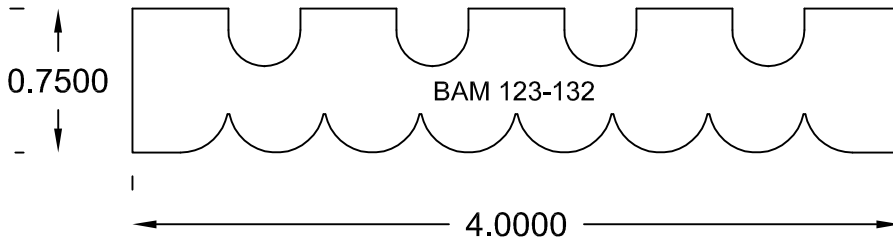
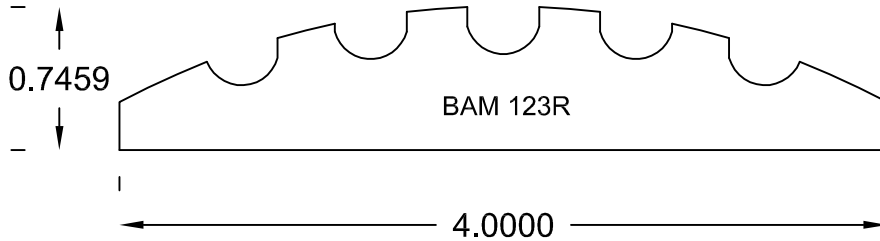

Traditional Collection Specification Sheet
These are STOCK items.

SCALE ~ 1:1
Date: 3/8/10 by:AEB
Spec Pg: 3

Bossen Architectural Millwork Inc.
© 2010
1818 Bannard Street
Cinnaminson, New Jersey 08077
PH 856-786-1100
FAX 856-786-3994
www.Mouldings-Etc.com

NOTICE
 All information contained within this document is the sole property of Bossen Architectural Millwork Inc. Any reproduction, misrepresentation, or alteration of this document without written permission is strictly prohibited.

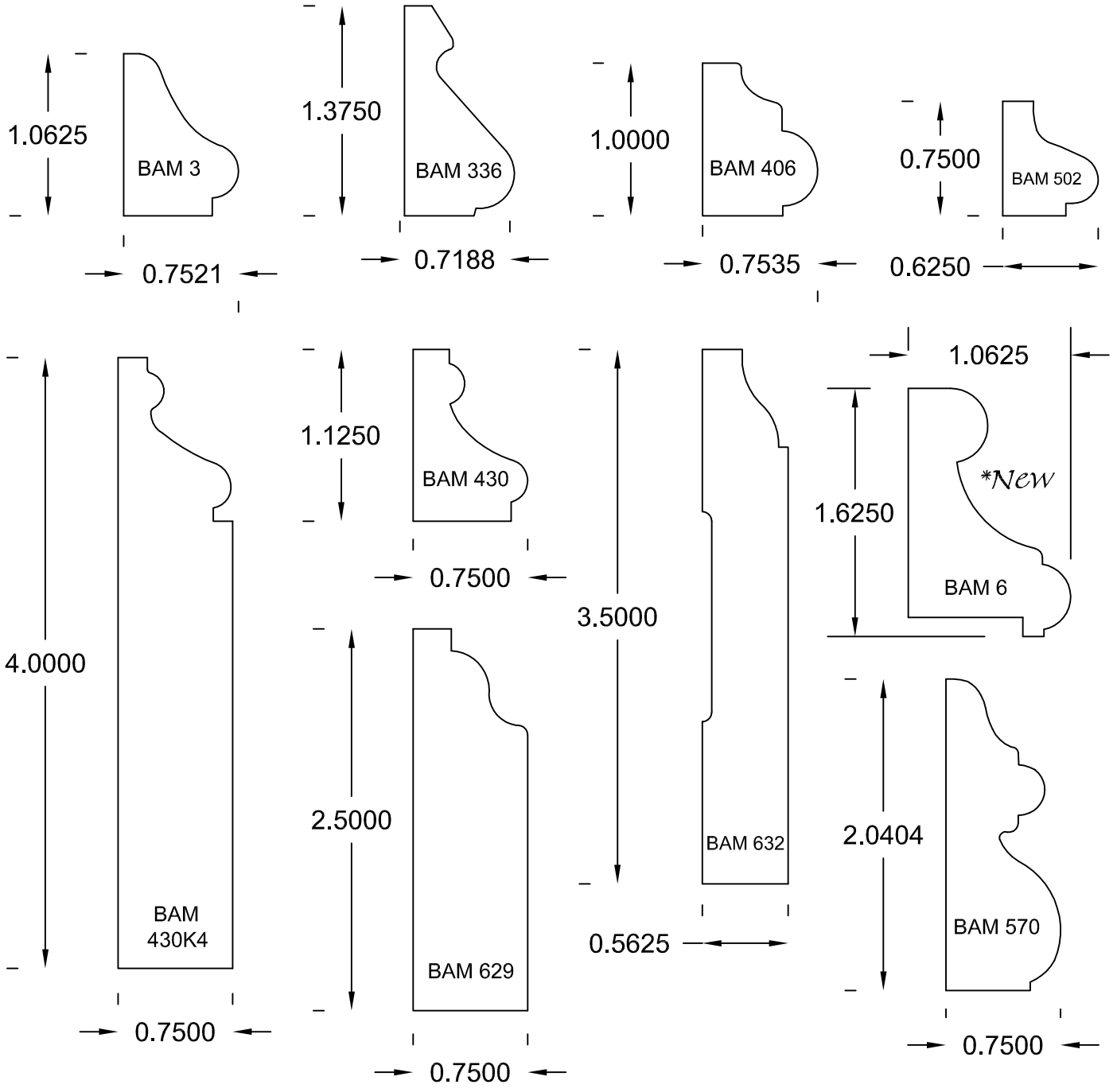

Traditional Collection Specification Sheet
 These are STOCK items.

SCALE ~ 1:1
 Date: 3/8/10 by:AEB
 Spec Pg: 4

Bossen Architectural Millwork Inc.
 © 2010
 1818 Bannard Street
 Cinnaminson, New Jersey 08077
 PH 856-786-1100
 FAX 856-786-3994
 www.Mouldings-Etc.com

NOTICE
All information contained within this document is the sole property of Bossen Architectural Millwork Inc. Any reproduction, misrepresentation, or alteration of this document without written permission is strictly prohibited.

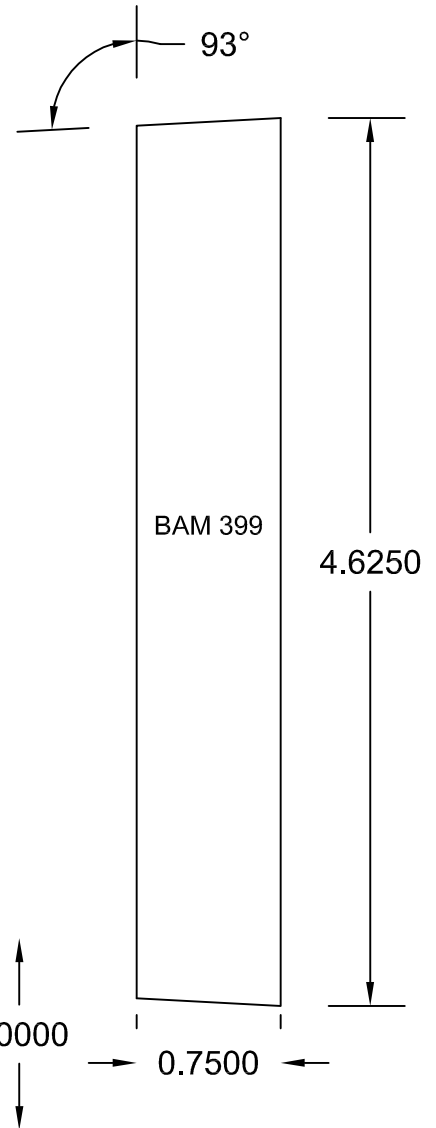
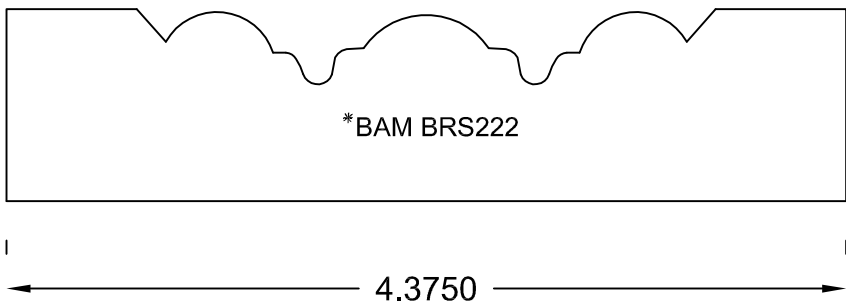
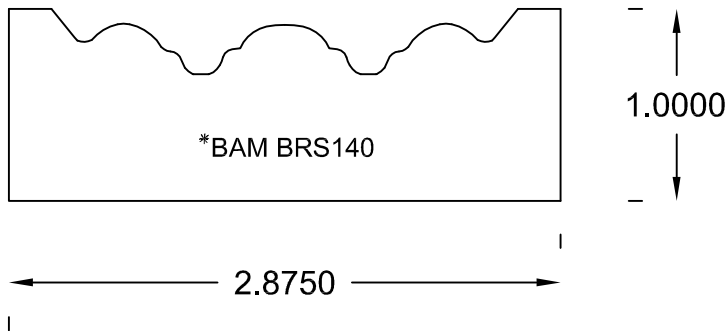
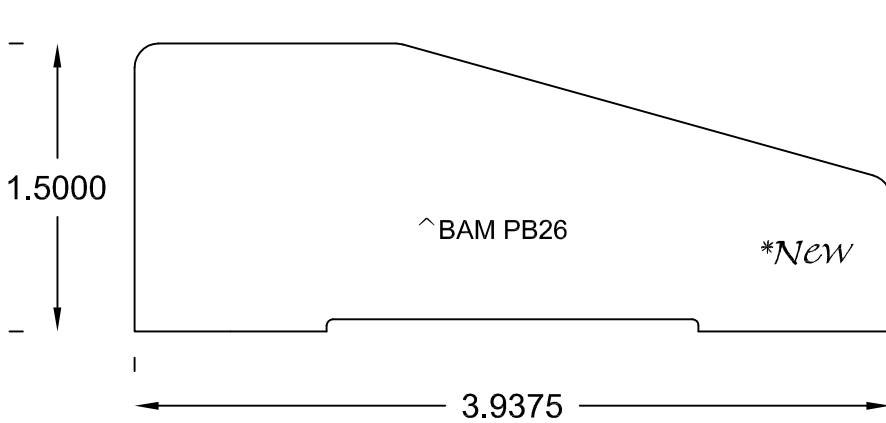

Traditional Collection Specification Sheet
These are STOCK items.
^Cross section of a plinth block.
*Cross section of a rosette.

SCALE ~ 1:1
Date: 3/8/10 by:AEB
Spec Pg: 5

Bossen Architectural Millwork Inc.
© 2010
1818 Bannard Street
Cinnaminson, New Jersey 08077
PH 856-786-1100
FAX 856-786-3994
www.Mouldings-Etc.com

NOTICE
All information contained within this document is the sole property of Bossen Architectural Millwork Inc. Any reproduction, misrepresentation, or alteration of this document without written permission is strictly prohibited.

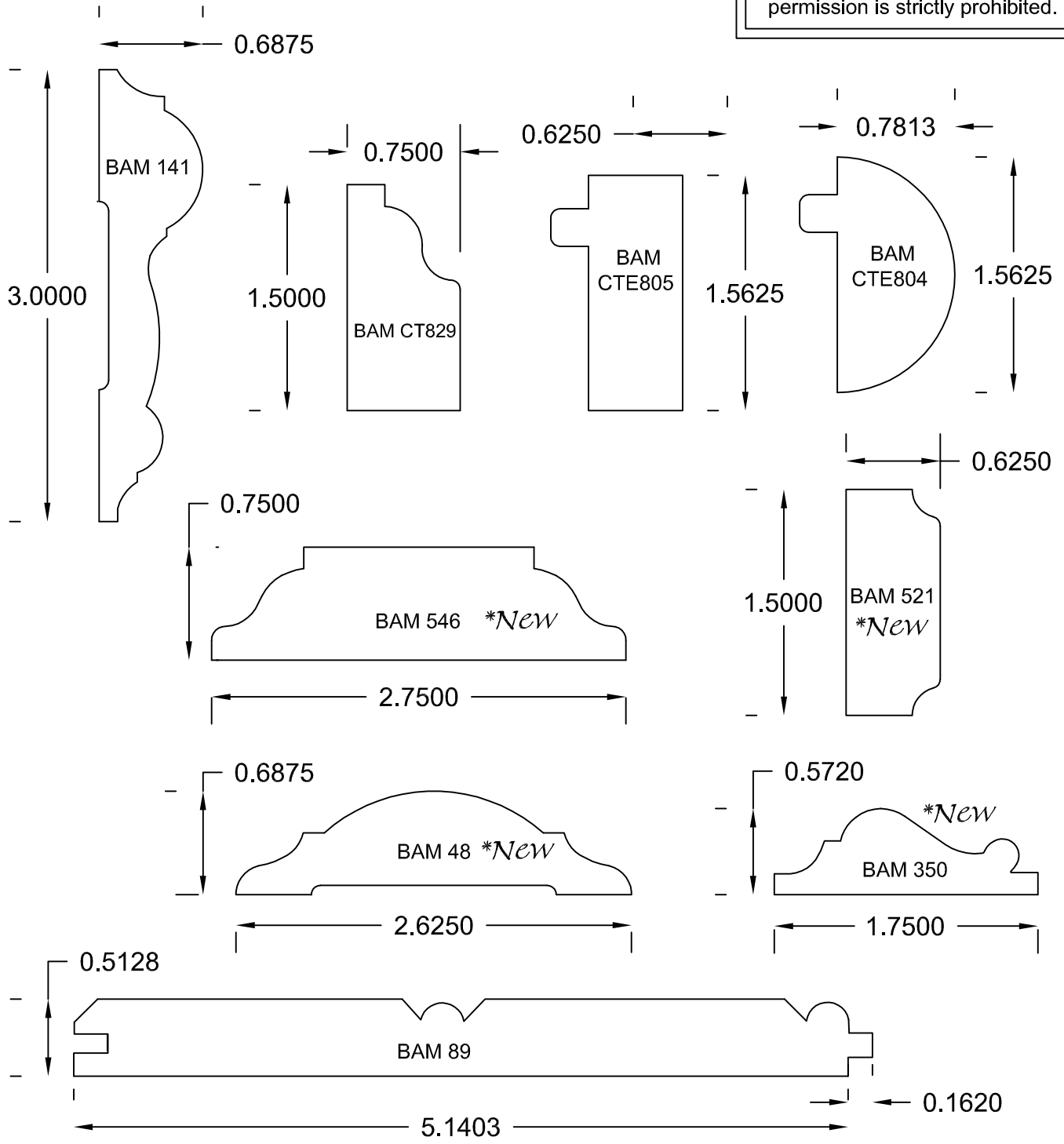

Traditional Collection Specification Sheet
These are STOCK items.

SCALE ~ 1:1
Date: 3/8/10 by:AEB
Spec Pg: 6

Bossen Architectural Millwork Inc.
© 2010
1818 Bannard Street
Cinnaminson, New Jersey 08077
PH 856-786-1100
FAX 856-786-3994
www.Mouldings-Etc.com

NOTICE
All information contained within this document is the sole property of Bossen Architectural Millwork Inc. Any reproduction, misrepresentation, or alteration of this document without written permission is strictly prohibited.

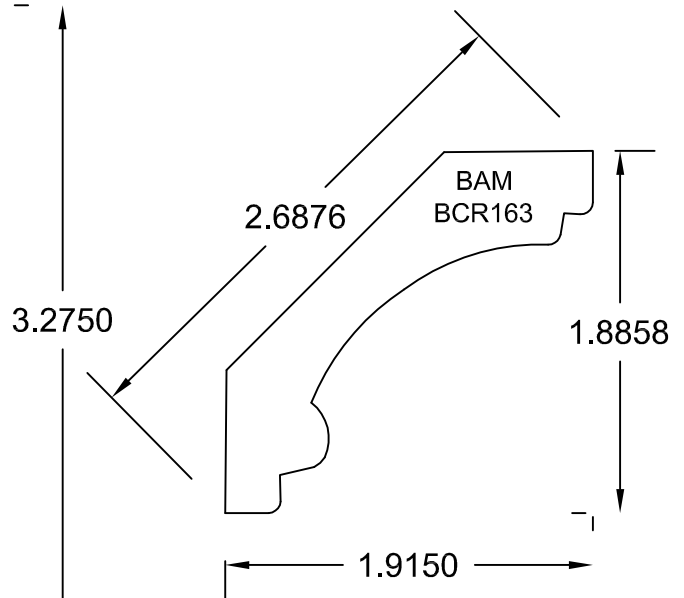
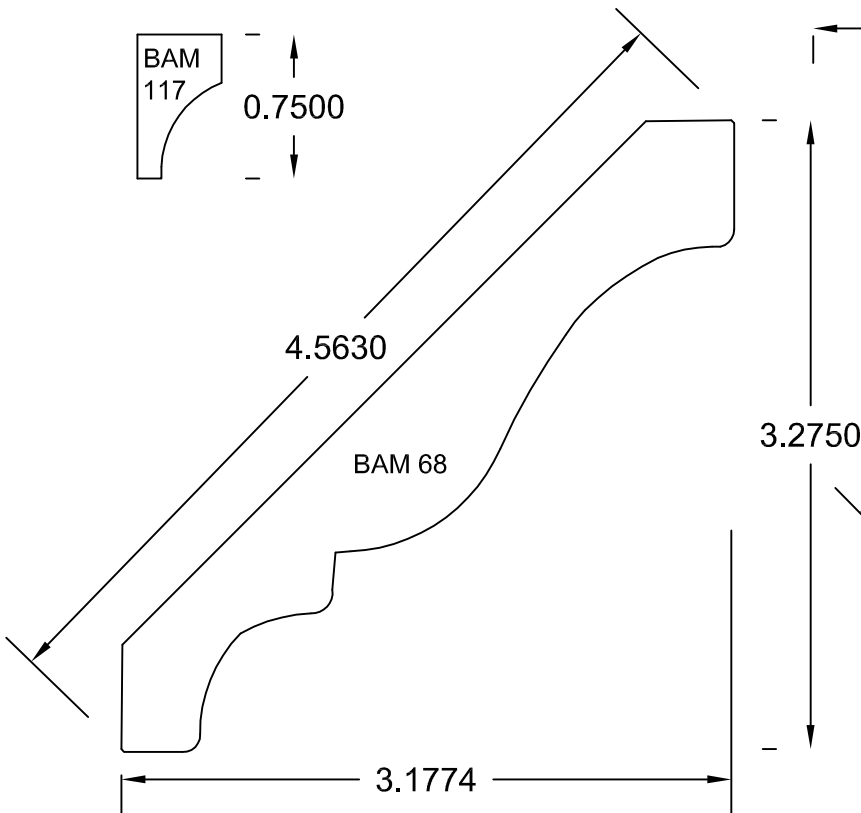
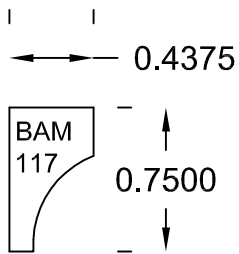
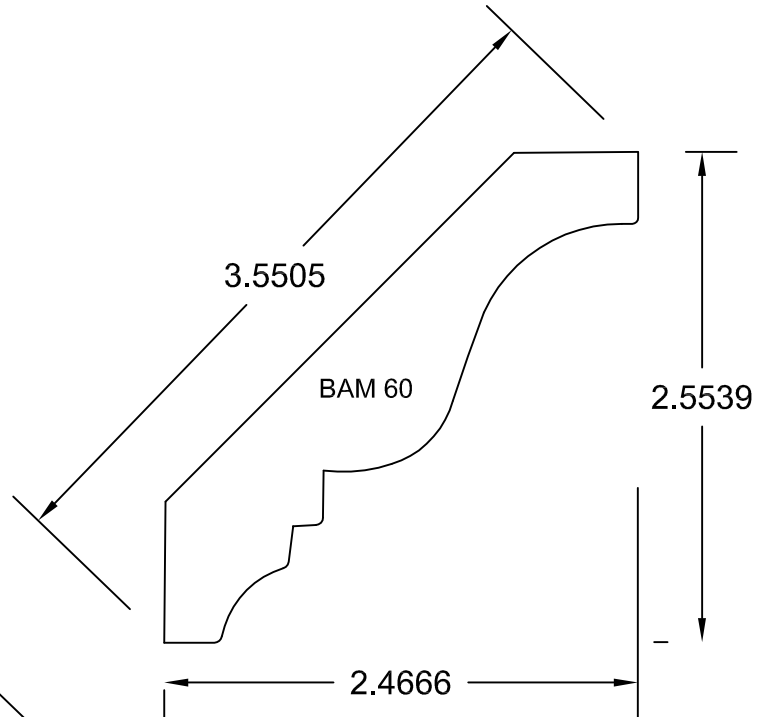
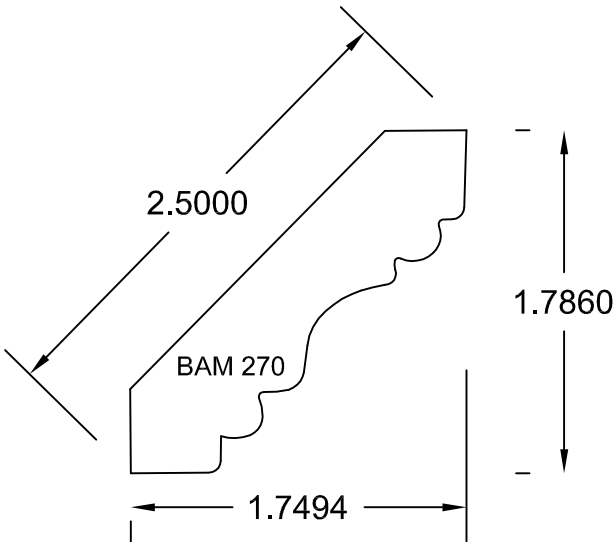
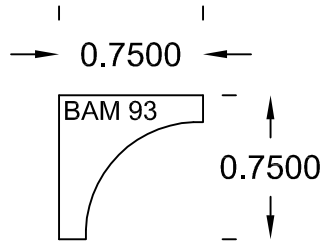

Traditional Collection Specification Sheet
These are STOCK items.

SCALE ~ 1:1
Date: 3/8/10 by:AEB
Spec Pg: 7

Bossen Architectural Millwork Inc.
© 2010
1818 Bannard Street
Cinnaminson, New Jersey 08077
PH 856-786-1100
FAX 856-786-3994
www.Mouldings-Etc.com

NOTICE
All information contained within this document is the sole property of Bossen Architectural Millwork Inc. Any reproduction, misrepresentation, or alteration of this document without written permission is strictly prohibited.

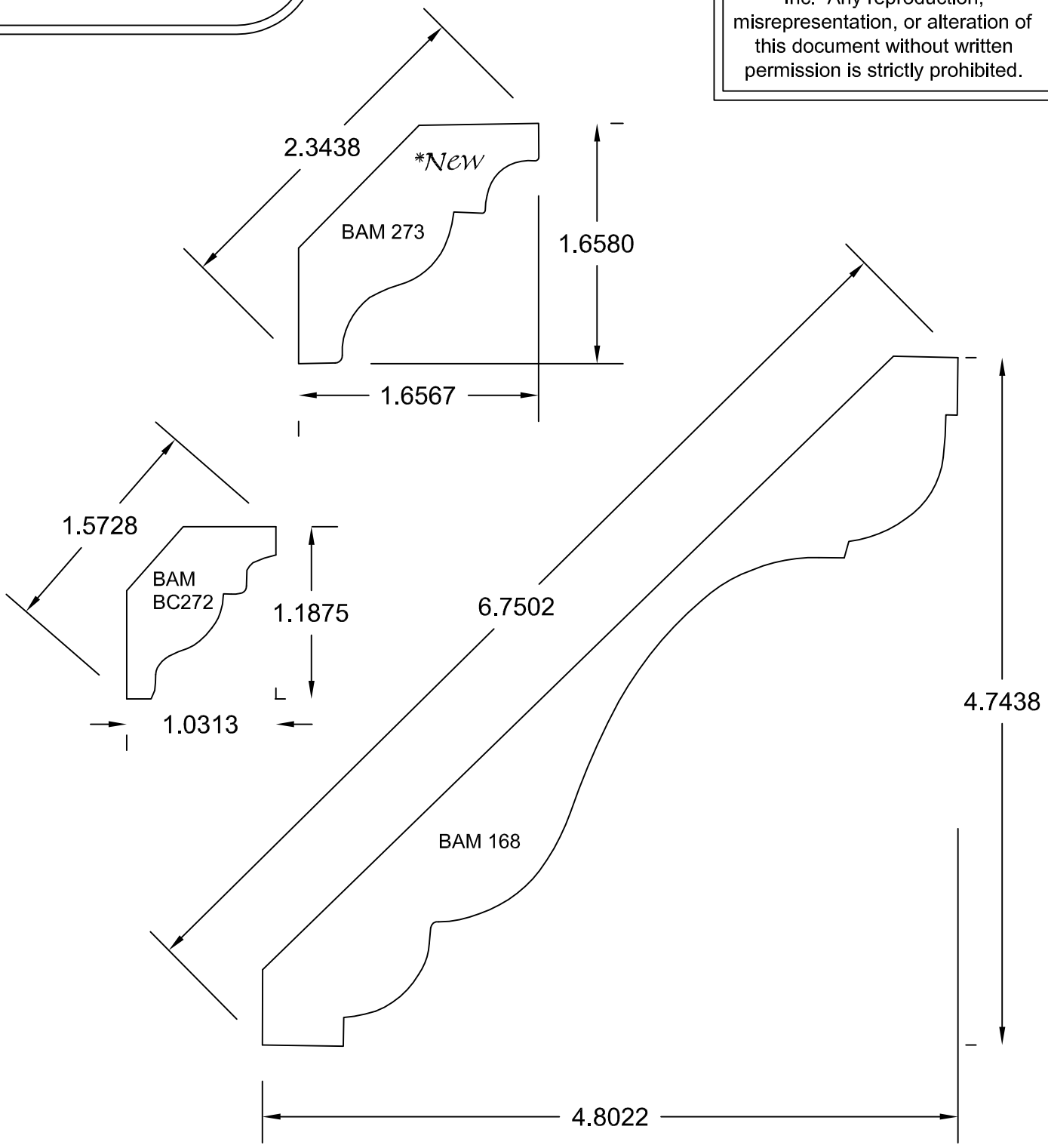

Traditional Collection Specification Sheet
These are STOCK items.

SCALE ~ 1:1
Date: 3/8/10 by:AEB
Spec Pg: 8

Bossen Architectural Millwork Inc.
© 2010
1818 Bannard Street
Cinnaminson, New Jersey 08077
PH 856-786-1100
FAX 856-786-3994
www.Mouldings-Etc.com

NOTICE
All information contained within this document is the sole property of Bossen Architectural Millwork Inc. Any reproduction, misrepresentation, or alteration of this document without written permission is strictly prohibited.

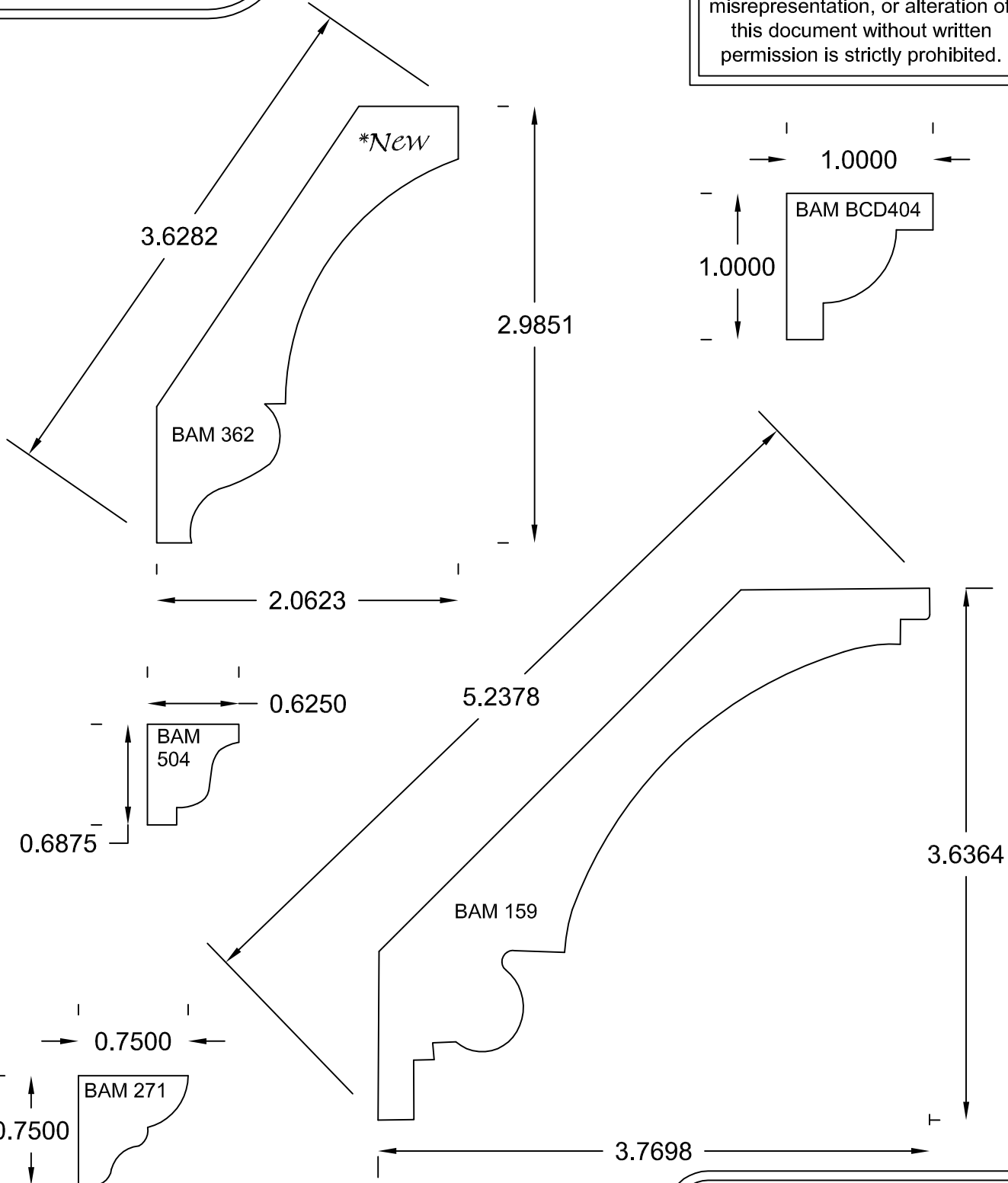

Traditional Collection Specification Sheet
These are STOCK items.

SCALE ~ 1:1
Date: 3/8/10 by:AEB
Spec Pg: 9

Bossen Architectural Millwork Inc.
© 2010
1818 Bannard Street
Cinnaminson, New Jersey 08077
PH 856-786-1100
FAX 856-786-3994
www.Mouldings-Etc.com

NOTICE
All information contained within this document is the sole property of Bossen Architectural Millwork Inc. Any reproduction, misrepresentation, or alteration of this document without written permission is strictly prohibited.

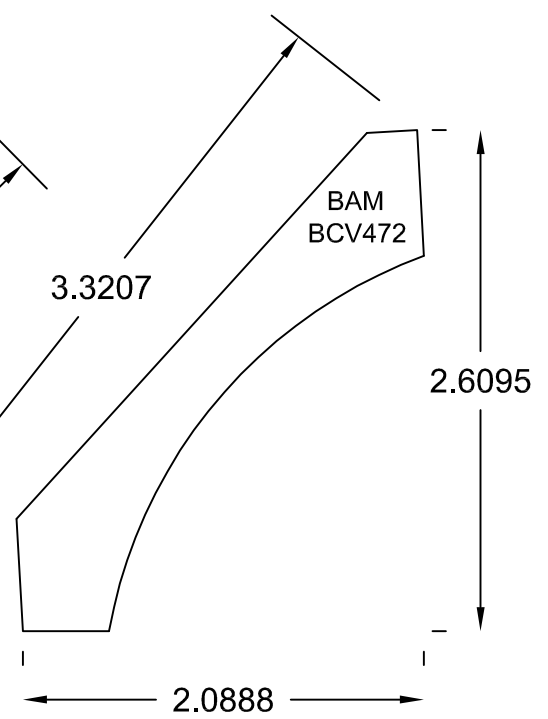
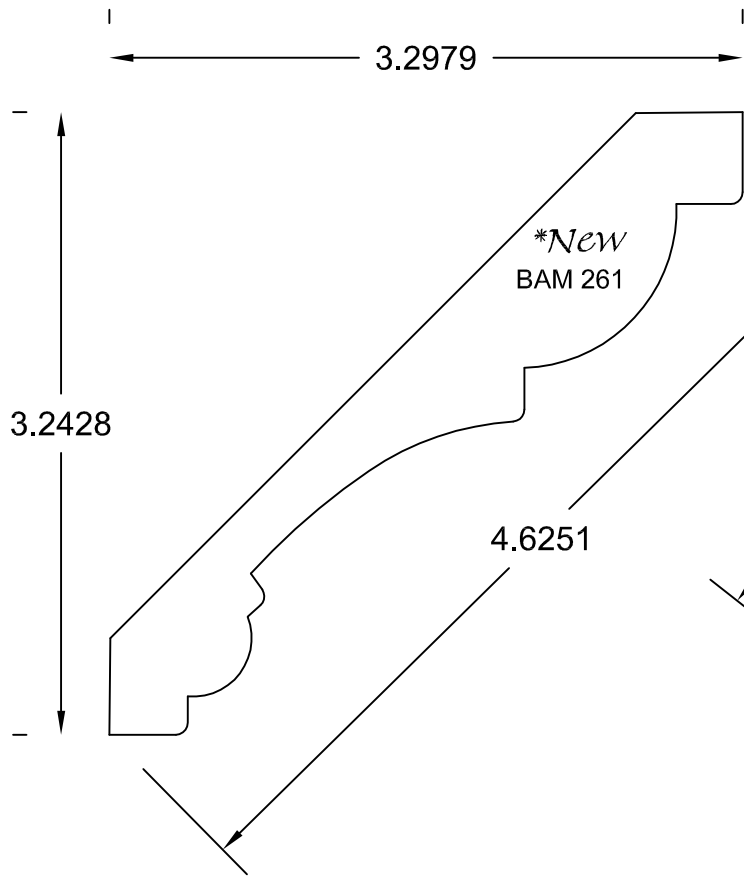
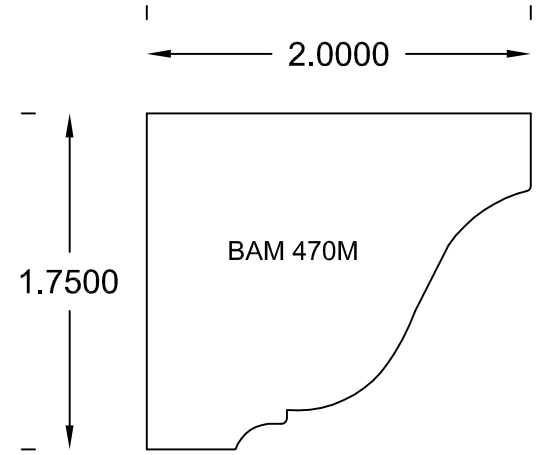
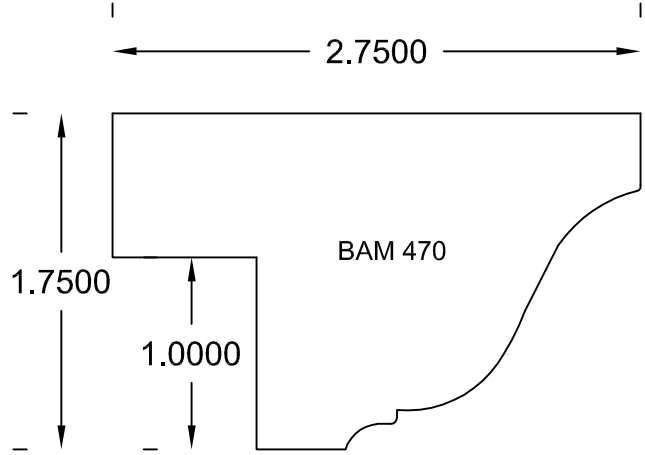
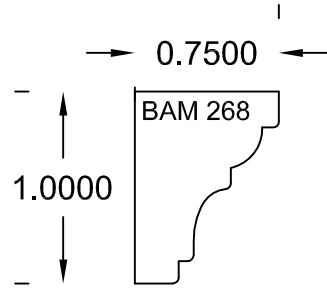

Traditional Collection Specification Sheet
These are STOCK items.

SCALE ~ 1:1
Date: 3/8/10 by:AEB
Spec Pg: 10

Bossen Architectural Millwork Inc.
© 2010
1818 Bannard Street
Cinnaminson, New Jersey 08077
PH 856-786-1100
FAX 856-786-3994
www.Mouldings-Etc.com

NOTICE
All information contained within this document is the sole property of Bossen Architectural Millwork Inc. Any reproduction, misrepresentation, or alteration of this document without written permission is strictly prohibited.

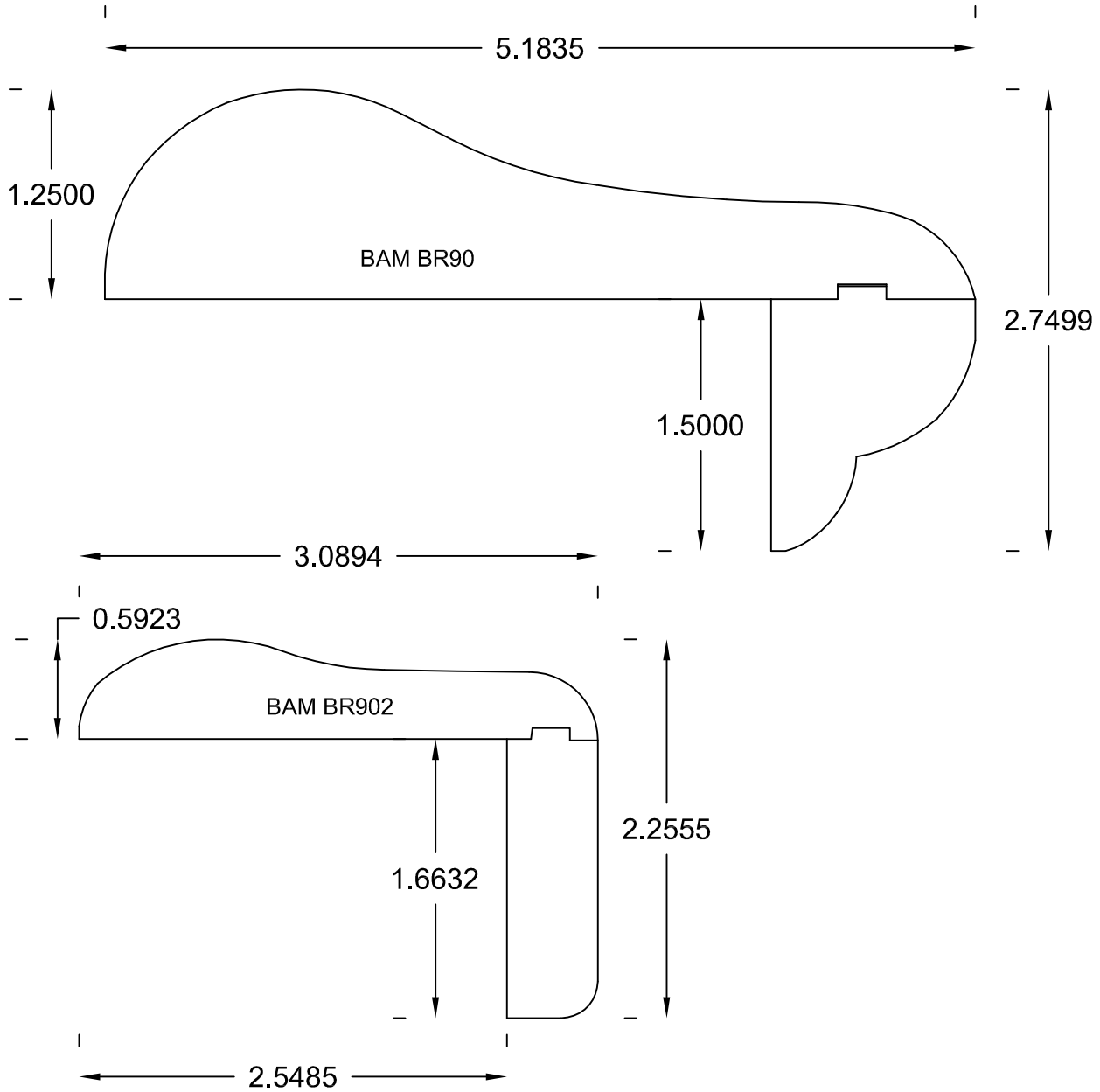

Traditional Collection Specification Sheet
These are STOCK items.

SCALE ~ 1:1
Date: 3/8/10 by:AEB
Spec Pg: 11

Bossen Architectural Millwork Inc.
® 2010
1818 Bannard Street
Cinnaminson, New Jersey 08077
PH 856-786-1100
FAX 856-786-3994
www.Mouldings-Etc.com

NOTICE

All information contained within this document is the sole property of Bossen Architectural Millwork Inc. Any reproduction, misrepresentation, or alteration of this document without written permission is strictly prohibited.

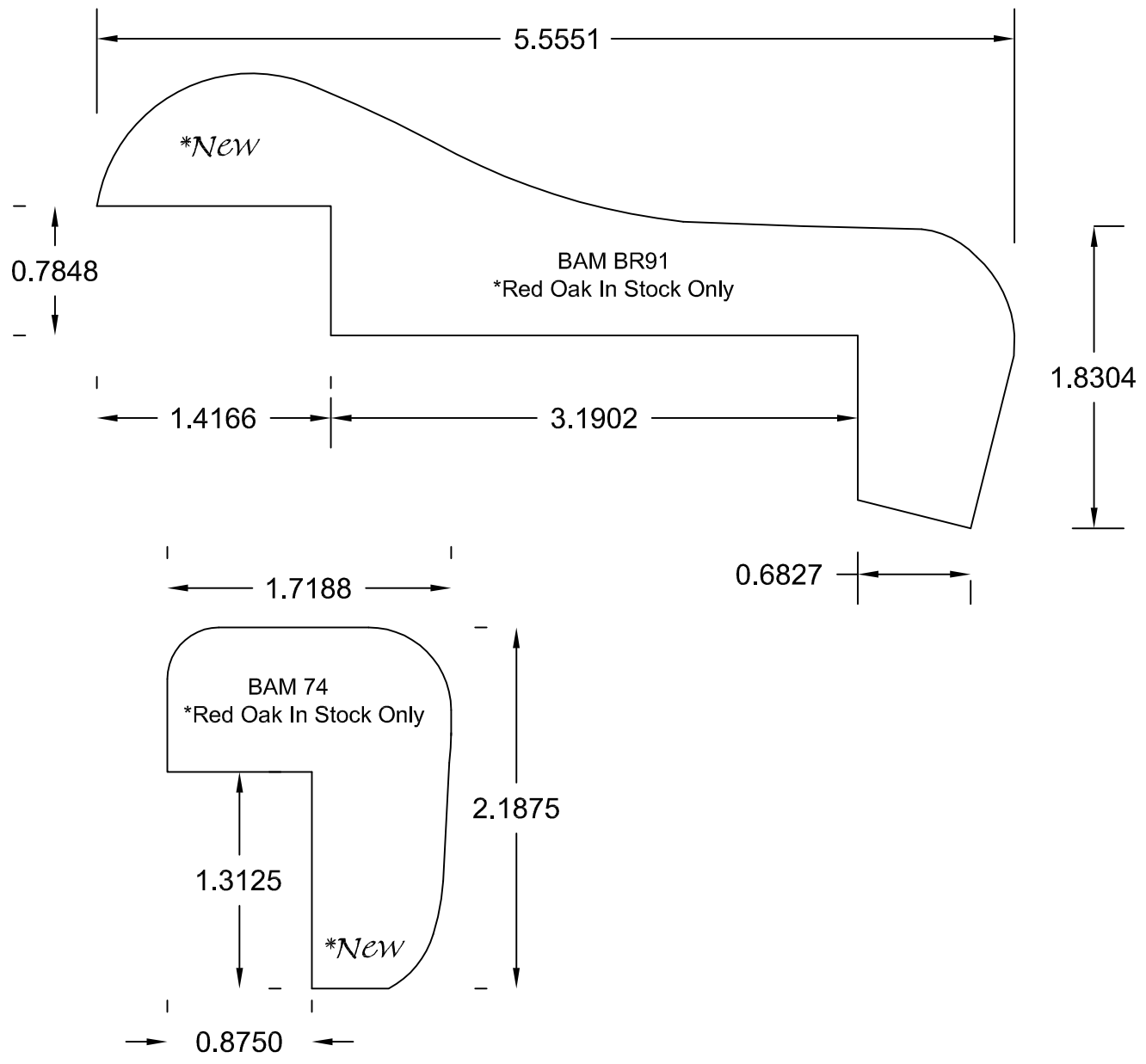

Traditional Collection Specification Sheet
These are STOCK items.
*May be special ordered in any species.

SCALE ~ 1:1
Date: 3/8/10 by:AEB
Spec Pg: 12

Bossen Architectural Millwork Inc.
© 2010
1818 Bannard Street
Cinnaminson, New Jersey 08077
PH 856-786-1100
FAX 856-786-3994
www.Mouldings-Etc.com

NOTICE
All information contained within this document is the sole property of Bossen Architectural Millwork Inc. Any reproduction, misrepresentation, or alteration of this document without written permission is strictly prohibited.

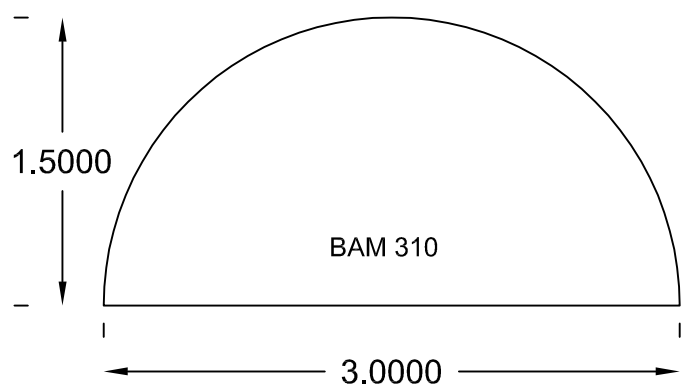
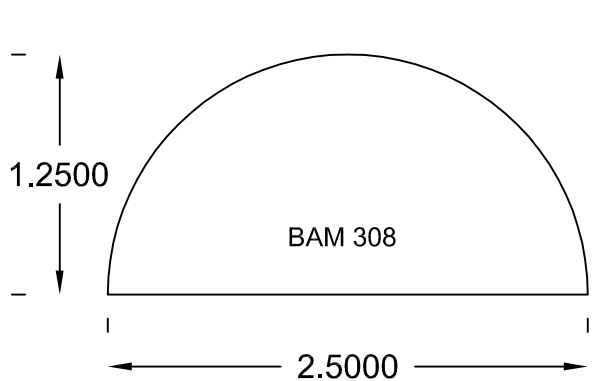
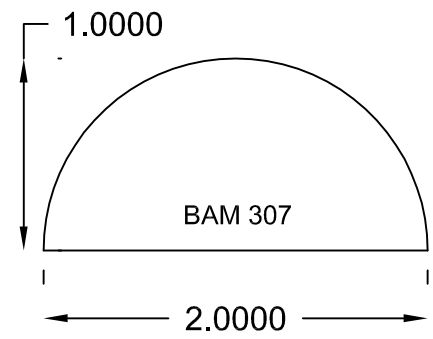
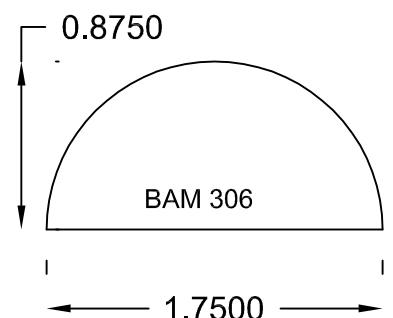
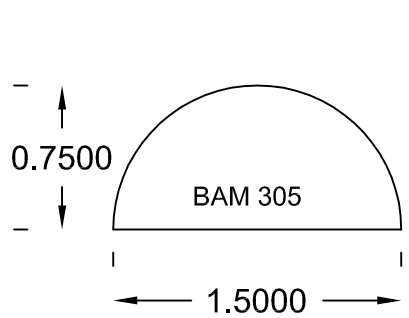
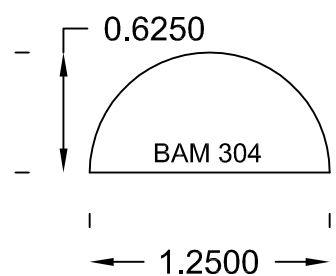
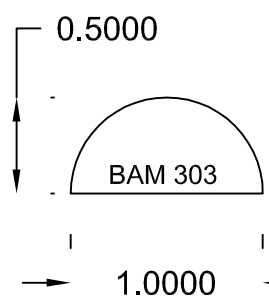
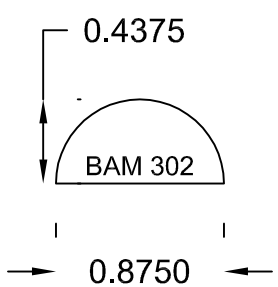
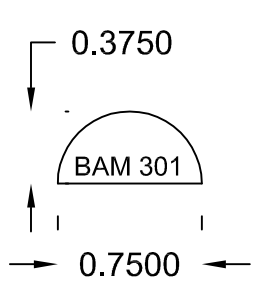
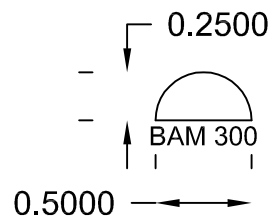
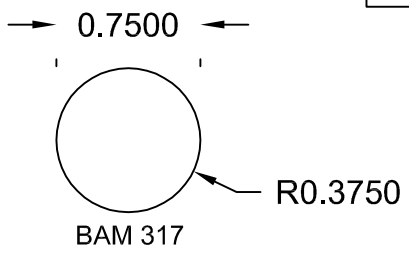
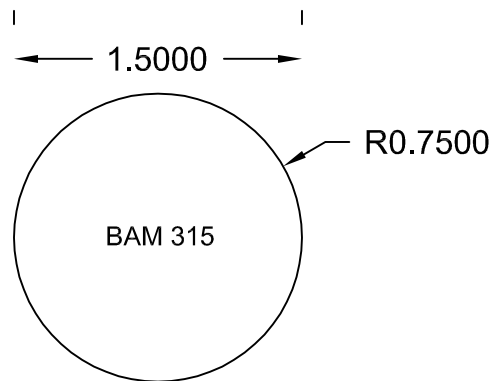

Traditional Collection Specification Sheet
These are STOCK items.

SCALE ~ 1:1
Date: 3/8/10 by:AEB
Spec Pg: 13

Bossen Architectural Millwork Inc.
© 2010
1818 Bannard Street
Cinnaminson, New Jersey 08077
PH 856-786-1100
FAX 856-786-3994
www.Mouldings-Etc.com

NOTICE

All information contained within this document is the sole property of Bossen Architectural Millwork Inc. Any reproduction, misrepresentation, or alteration of this document without written permission is strictly prohibited.

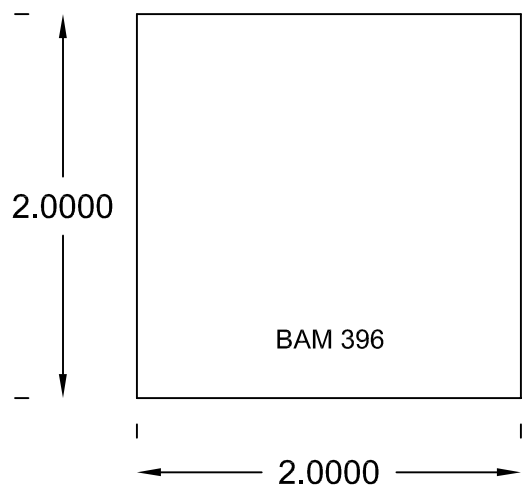
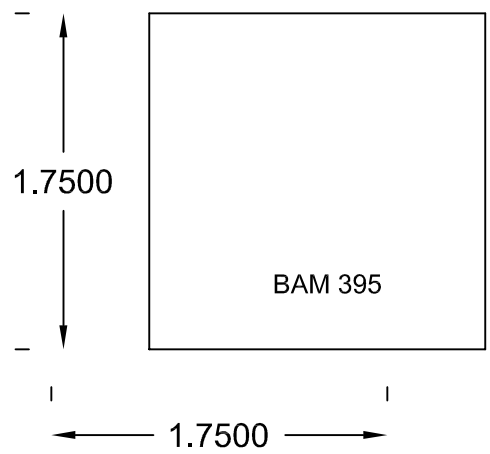
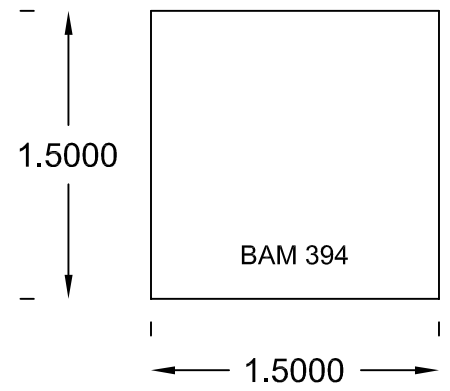
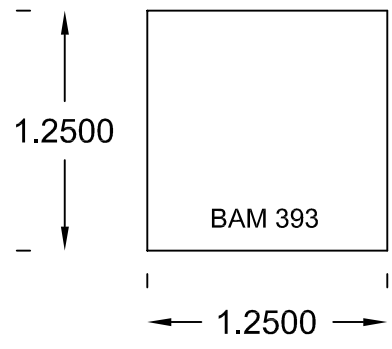
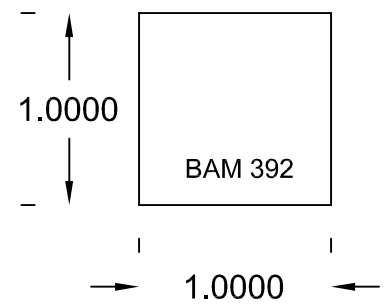
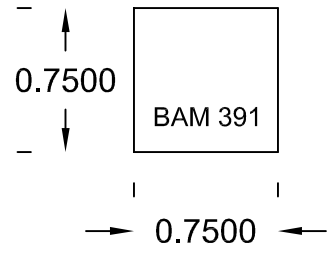
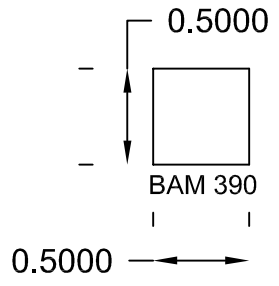

Traditional Collection Specification Sheet
These are STOCK items.

SCALE ~ 1:1
Date: 3/8/10 by:AEB
Spec Pg: 14

Bossen Architectural Millwork Inc.
© 2010
1818 Bannard Street
Cinnaminson, New Jersey 08077
PH 856-786-1100
FAX 856-786-3994
www.Mouldings-Etc.com

NOTICE
All information contained within this document is the sole property of Bossen Architectural Millwork Inc. Any reproduction, misrepresentation, or alteration of this document without written permission is strictly prohibited.

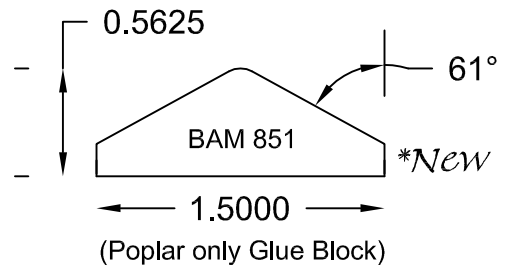
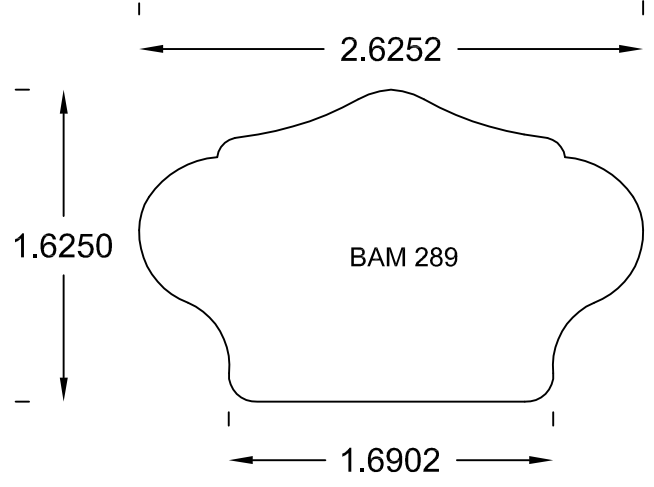
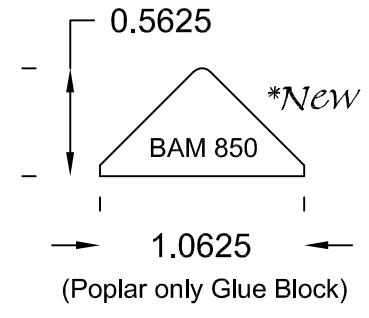
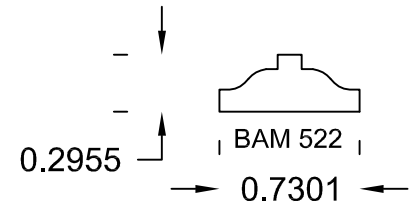
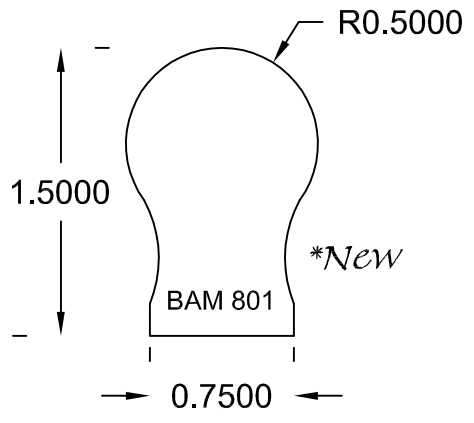
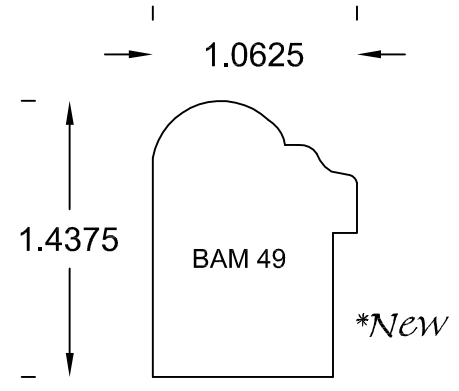
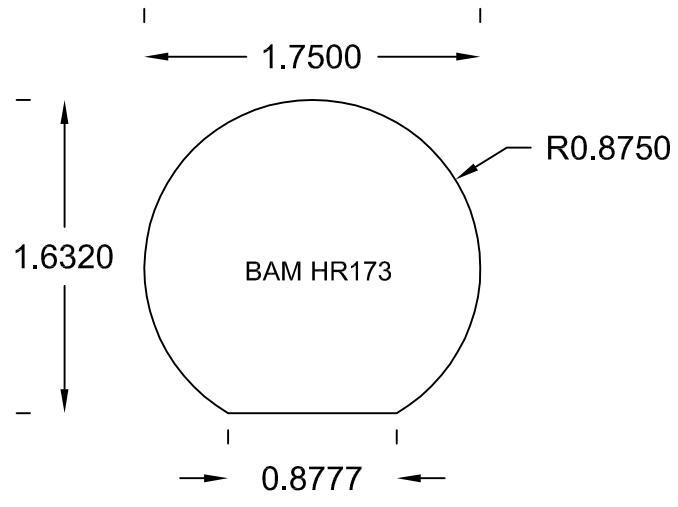

Traditional Collection Specification Sheet
These are STOCK items.

SCALE ~ 1:1
Date: 3/8/10 by:AEB
Spec Pg: 15

Bossen Architectural Millwork Inc.
© 2010
1818 Bannard Street
Cinnaminson, New Jersey 08077
PH 856-786-1100
FAX 856-786-3994
www.Mouldings-Etc.com

NOTICE
All information contained within this document is the sole property of Bossen Architectural Millwork Inc. Any reproduction, misrepresentation, or alteration of this document without written permission is strictly prohibited.

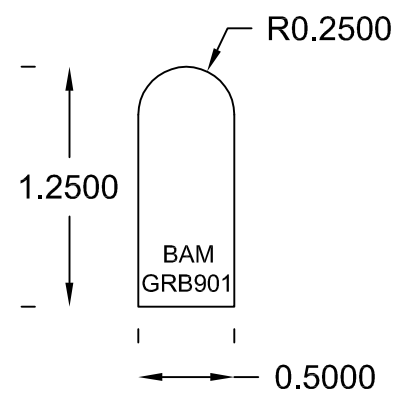
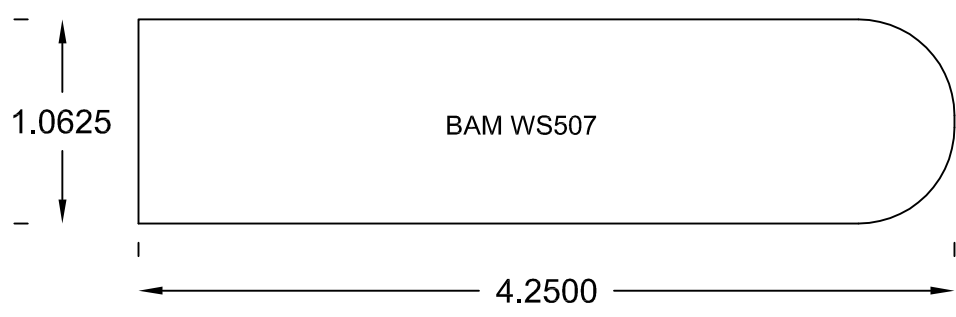
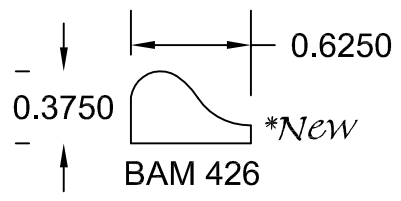
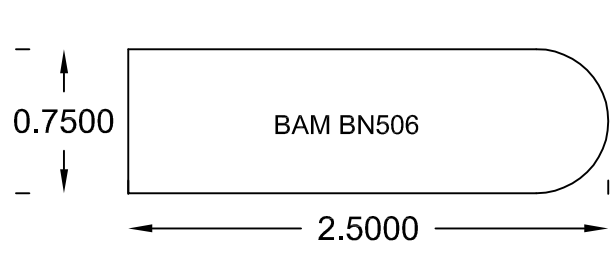
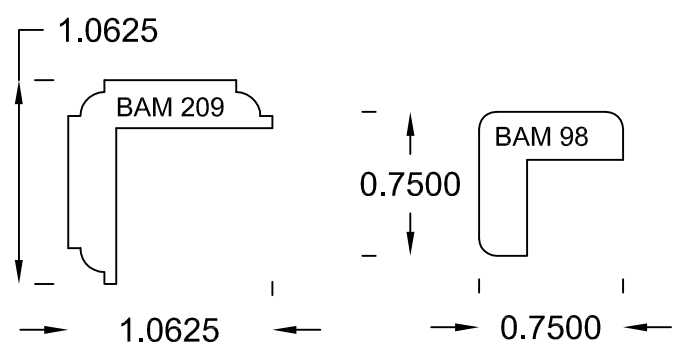
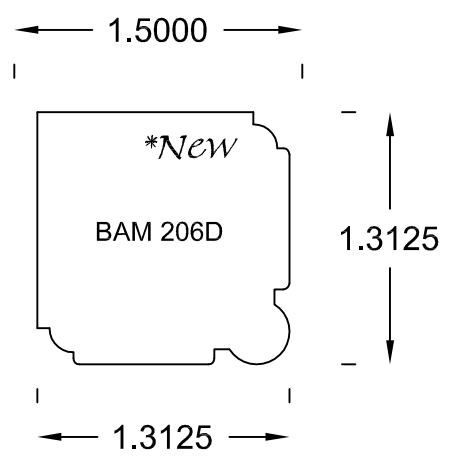
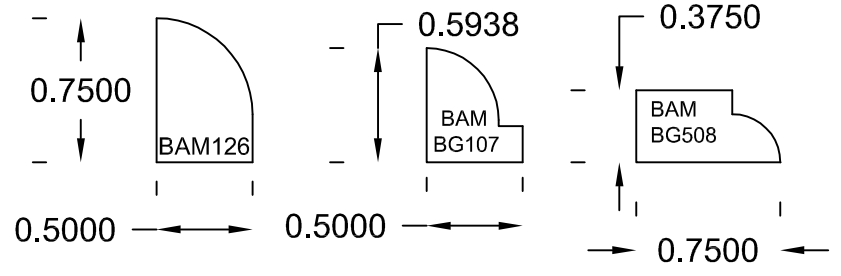
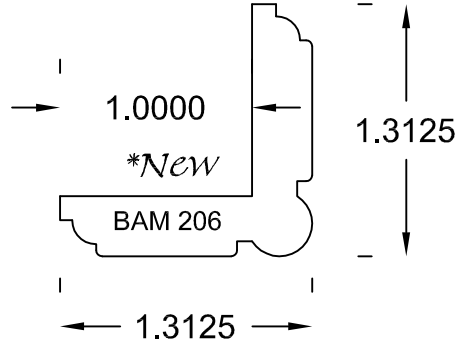

Traditional Collection Specification Sheet
These are STOCK items.

SCALE ~ 1:1
Date: 3/8/10 by:AEB
Spec Pg: 16

Bossen Architectural Millwork Inc.
© 2010
1818 Bannard Street
Cinnaminson, New Jersey 08077
PH 856-786-1100
FAX 856-786-3994
www.Mouldings-Etc.com

NOTICE
 All information contained within this document is the sole property of Bossen Architectural Millwork Inc. Any reproduction, misrepresentation, or alteration of this document without written permission is strictly prohibited.

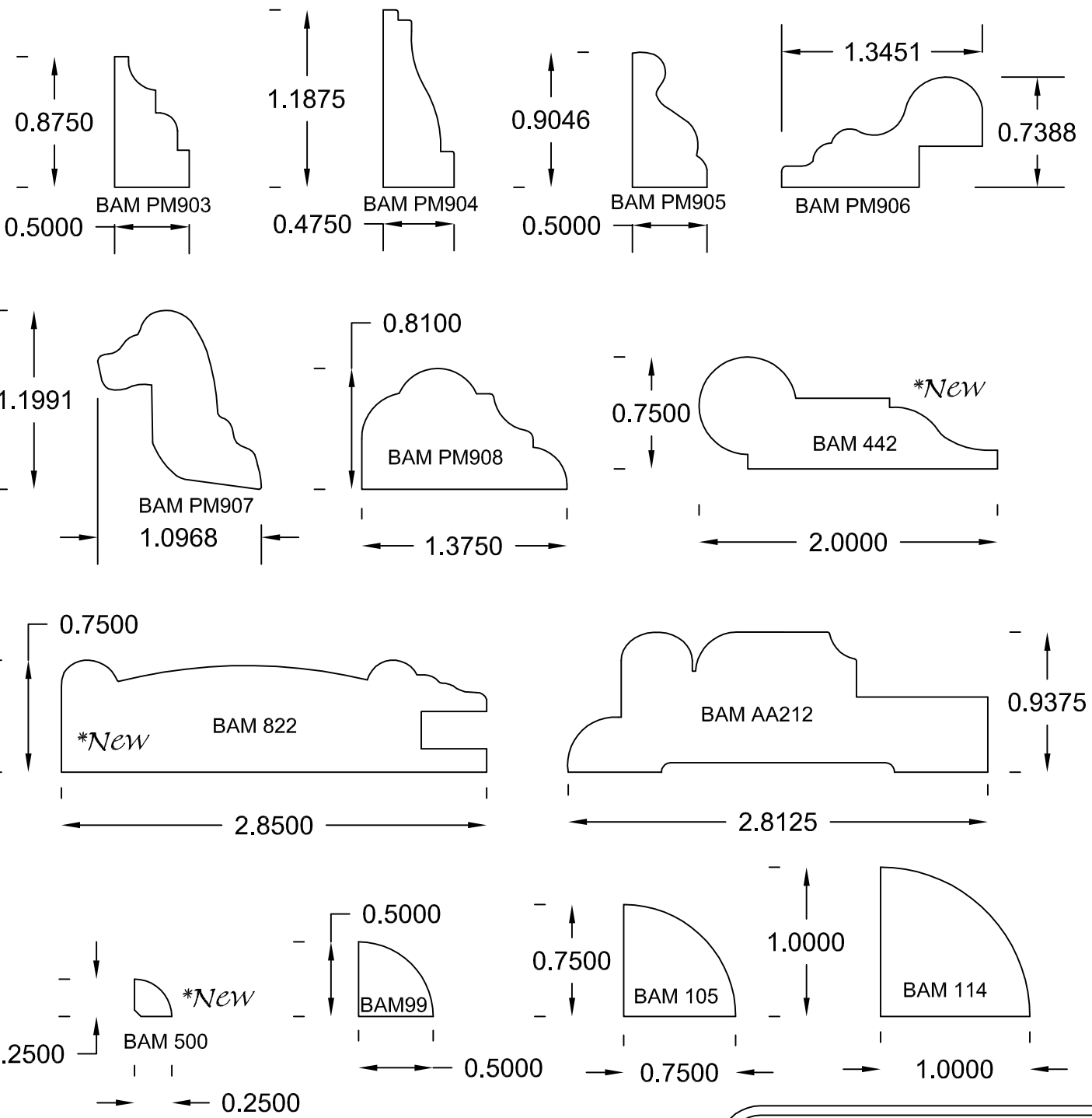

Traditional Collection Specification Sheet
 These are STOCK items.

SCALE ~ 1:1
 Date: 3/8/10 by:AEB
 Spec Pg: 17

Bossen Architectural Millwork Inc.
 © 2010
 1818 Bannard Street
 Cinnaminson, New Jersey 08077
 PH 856-786-1100
 FAX 856-786-3994
 www.Mouldings-Etc.com

NOTICE
 All information contained within this document is the sole property of Bossen Architectural Millwork Inc. Any reproduction, misrepresentation, or alteration of this document without written permission is strictly prohibited.

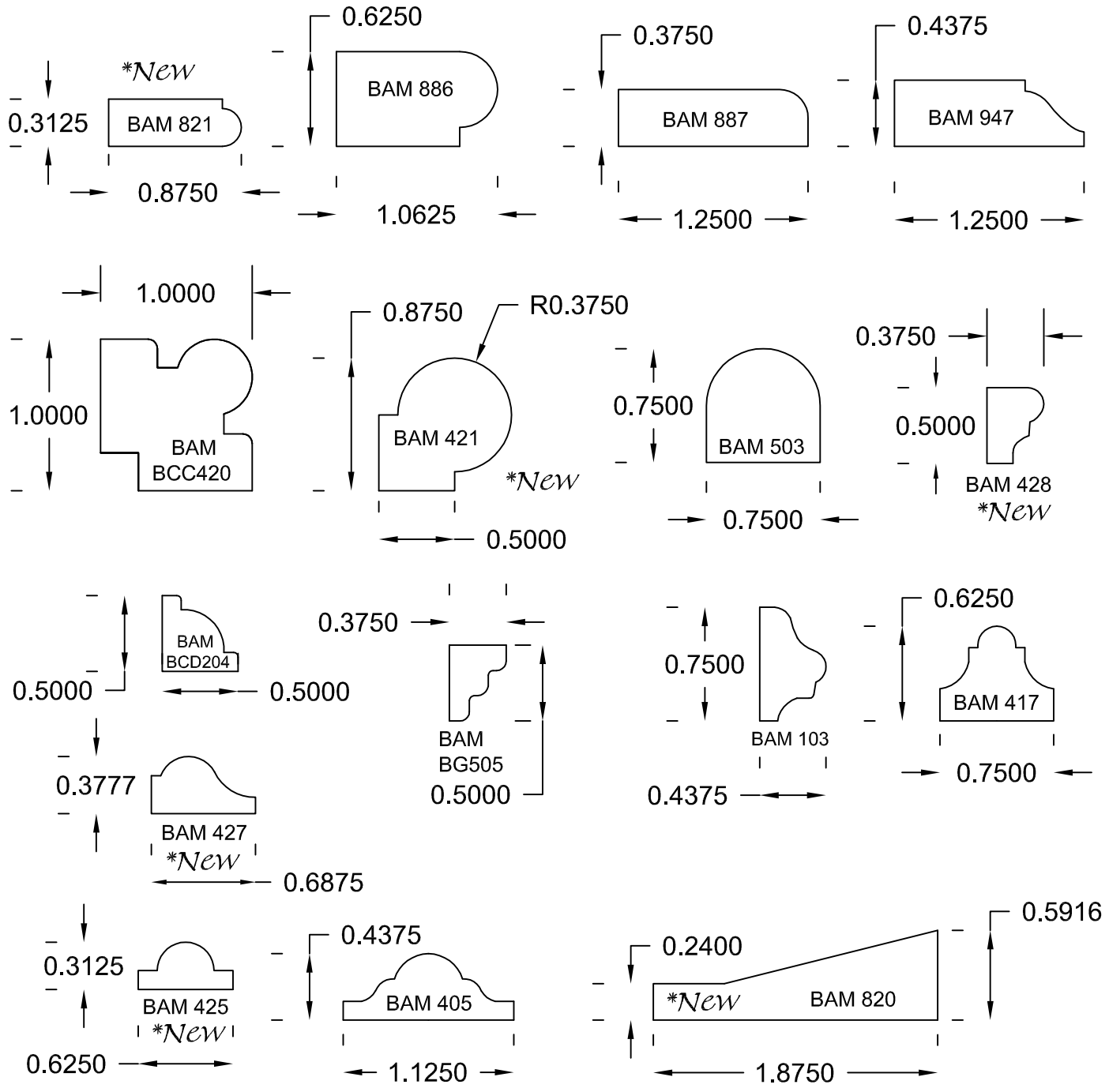

Traditional Collection Specification Sheet
 These are STOCK items.

SCALE ~ 1:1
 Date: 3/8/10 by:AEB
 Spec Pg: 18

Bossen Architectural Millwork Inc.
 © 2010
 1818 Bannard Street
 Cinnaminson, New Jersey 08077
 PH 856-786-1100
 FAX 856-786-3994
 www.Mouldings-Etc.com